SpectraPure[®]

The LiterMeter III

Precision Dosing System

Installation and Operating Manual



SpectraPure[®]

System Description	3
System Specifications	3
System Features	4
Other Applications	4
Controls and Components	5
System Setup	6
Calibrating	7
Programming	8
Over Limit	8
System Operation	9
The Lights	10
The Buttons	10
The Information Display	10
Navigation Aids	11-12
Maintenance	13
Accessories	15
Two-Way Water Exchange	16
Dosing Multi-Part Additives	17
Hydroponics System Example	18
Controlling Other Devices	18
Troubleshooting & Accessories	19
Servicing	20-23
Warranty Information	24

Copyright © 2002-2009 by **SpectraPure®Inc.**

ALL RIGHTS RESERVED

No part of this publication may be reproduced, stored in a retrieval system, or transmitted in any form or by any means, electronic, mechanical, photocopying, recording or otherwise without the prior written permission of SpectraPure Inc.

SpectraPure®Inc. 480.894.5437 Call us toll-free 1.800.685.2783

2 2167 East Fifth Street, Tempe, Arizona 85281-2941

SpectraPure[®]

SYSTEM DESCRIPTION:

The LiterMeter III is a precision liquid dosing system with independent control of three peristaltic pumps, one is internal and two more can be remotely connected. The pumps may be of different sizes and flow rates.

The LiterMeter III offers features found only on expensive laboratory pumps, such as microprocessor control and non-volatile memory. Unlike noisy industrial metering pumps sold to the aquarium trades, the LiterMeter III was specially designed for critical aquarium dosing and is so quiet you can use it in your living room. Superior three-roller direct-motor drive eliminates noisy gears and improves flow accuracy and tubing life. It can be run dry without damage.

Calcium maintenance and alkalinity control are essential for a healthy reef tank. The LiterMeter III eliminates the manual drudgery of dosing Kalkwasser or trace elements, and topping off evaporated water. Kalkwasser replenishment, to be most effective, should be added to your aquarium slowly and consistently to avoid precipitation of calcium carbonate. The LiterMeter III automatically and reliably performs this task for you.

Other dosing and mixing operations involving 2- and 3-part formulae can be precisely metered and monitored. Two-way water exchanges can be performed automatically.

SYSTEM SPECIFICATIONS:

- **Internal Pump Flow Rate:** approx. 250 ml/min. (8.45 oz./min.)
- **Dimensions:** 7.5" x 3.7" x 2.2" (19 cm. x 9.4 cm. x 5.6 cm.)
- **Minimum Daily Total (per Pump):** 50 milliliters (1.7 oz.)
- **Maximum Daily Total (per Pump):** 99 liters (26 gals.)
- **Draw Height:** from maximum **25 feet** (7.7 meters) below
- **Delivery Height:** to maximum **60 feet** (18.5 meters) above
- Each pump doses equal amounts 150 times per day
- 1 115VAC / 12VDC wall-mounted power supply
- International power supply available: 230VAC
- Uses less than 6 Watts of power when operating one pump
- Can be powered directly from a 12VDC battery

SpectraPure[®]

SYSTEM FEATURES

- New and Improved Pump. Highest quality and accuracy
- Fully automatic operation - Set it and forget it
- All metal pump housing
- Auto-Calibration feature
- Virtually maintenance free
- No check valves to clog or seals to leak
- Self-priming and anti-siphoning
- Higher delivery pressure
- Compact size and cool operation
- Kalkwasser safe
- No damage to the unit if run dry
- Quiet operation and low power consumption
- Complete system consumes less than 6 Watts when pump is on
- Extended 5-year warranty

OTHER APPLICATIONS

- Automatic Invertebrate Feeding
- Hydroponics Nutrient Dosing and Mixing
- Bio-Remediation
- Methanol Dosing for Bio-Reactors and De-Nitrifiers
- 2-part calcium additives, such as B-Ionic and C-Balance products
- Laboratory use

SpectraPure®

CONTROLS AND COMPONENTS

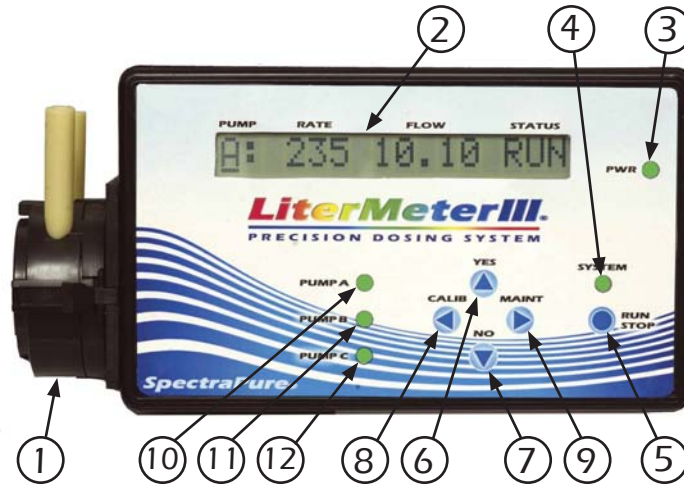

LiterMeter III Controls and Components

- | | |
|-------------------------------|--------------------------|
| 1. Pump Head | 10. Pump "A" Indicator |
| 2. Information Display | 11. Pump "B" Indicator |
| 3. Power Indicator | 12. Pump "C" Indicator |
| 4. System Operation Indicator | 13. Power Input Jack |
| 5. RUN/STOP Button | 14. Pump "A" Output Jack |
| 6. UP Button (YES) | 15. Pump "B" Output Jack |
| 7. DOWN Button (NO) | 16. Pump "C" Output Jack |
| 8. LEFT Button (CALIBrate) | |
| 9. RIGHT Button (MAINTenance) | |

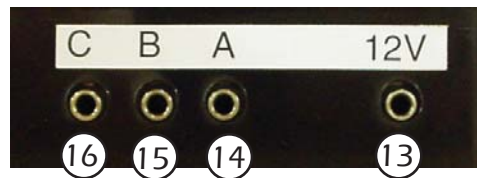

LiterMeter III Side View

SpectraPure®

SYSTEM SET-UP

1. Press-fit the end of a piece of ¼" polyethylene tubing into the rubber **inlet** hose at least ½". Secure with a provided cable tie. This is connected to the supply reservoir. This reservoir needs to be vented to prevent occlusion
2. Insert the end of a piece of ¼" polyethylene tubing into the white connector on the **outlet** hose until firmly seated. This should lead to your aquarium (or sump).
3. Although the peristaltic pump inherently prevents back-flow conditions, it is always good practice to locate the LiterMeter above and to the side of the supply vessel and aquarium (or sump). Providing an air-gap between the hose end and the top-most water level in the aquarium is also accepted practice. Note: when metering Kalkwasser, the end of the tubing will eventually become calcified and interfere with the flow. To prevent this, it is suggested that the end of the dispensing tubing be inspected and cleaned periodically.
4. The supply reservoir can be any size and located as much as 30 feet below the LiterMeter. If the LiterMeter is located at the same level as the supply tank, delivery to a height of 60 feet above the LiterMeter is possible.
5. Connect the 12 VDC, 500 mA power supply to the power jack (13) on the side of the LiterMeter III, and then to any proper 120 VAC source (230 VAC power supply available).

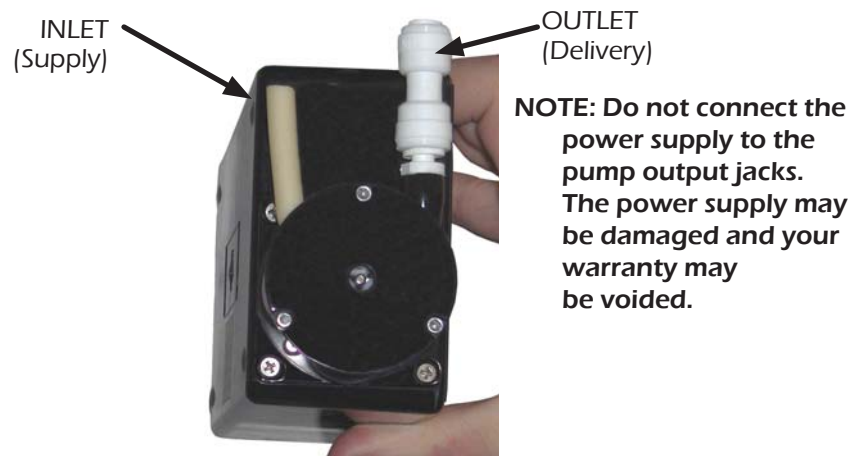

SpectraPure®Inc. 480.894.5437 Call us toll-free 1.800.685.2783

SpectraPure®

CALIBRATING THE LiterMeter III:

All peristaltic pumps exhibit a “breaking-in” period where the tubing needs to become “seated” in the pump head. Variations in pumping height and liquid viscosity will also affect the flow RATE of the pump. Over time, these pumps may slightly change their flow RATE characteristics and need to be re-calibrated periodically. Always run a new (or serviced) pump dry for *20 minutes before calibrating*.

Calibration is most accurate if it is performed with all delivery tubing installed. Line losses will then be included in the calibration.

The LiterMeter III needs to know each pump’s flow RATE. This procedure will automatically determine the actual flow RATE of the pump(s) and set the RATE value in the display window. You cannot change this number, only the Calibration routine can change this number.

- | | | |
|------------------|---|---|
| *ALL PUMPS OFF* | ↓ | 1: When *ALL PUMPS OFF* is displayed, place the intake hose of Pump A into the vessel (larger than 500 mL) of liquid to be calibrated. Place the output hose into a 500 mL measuring cup. |
| ⏪ (CALIB) | | 2: Press the RUN/STOP button and then turn ON the pump to be calibrated long enough to be sure that the pump is “primed” and ready to dispense the liquid. Press the RUN/STOP button to return to *ALL PUMPS OFF*. Empty the measuring cup. |
| A: START CALIB?^ | | |
| ⏩ (YES) | | 3: Enter Calibrate Mode by pressing the CALIB button (LEFT). |
| A: 500mL FULL?^ | | |
| ⏩ (YES) | | 4: Press the YES button (UP) to begin to fill the measuring cup. |
| B: START CALIB?^ | | |
| ⏩ (YES) | | 5: When the cup has filled to the 500 mL mark, press the YES button (UP) again. |
| B: 500mL FULL?^ | | |
| ⏩ (YES) | | 6: The pump will shut off and the RATE of the pump will be calculated and displayed in mL/min. for a short time before continuing on to the Pump B calibration. |
| C: START CALIB?^ | | |
| ⏩ (YES) | | 7: If there are no more pumps to calibrate, press the NO button (DOWN) to cancel subsequent calibrations and return to the *ALL PUMPS OFF* display. |
| C: 500mL FULL?^ | | |
| ⏩ (YES) | | |
| *ALL PUMPS OFF* | | |

SpectraPure[®]

PROGRAMMING

One of the most common uses of the LiterMeter III is to dispense a metered amount of kalkwasser on a daily basis from a reservoir containing many days' worth.

- 1) Review the Navigation Aids on pages 11-12 to familiarize yourself with using the buttons.
- 2) CALIBrate the individual pump(s) (See page 7). This computes the actual ability of the pump to move liquid in milliliters per minute and is displayed under RATE.
- 3) Set the FLOW value for the **total amount in liters** you wish to dispense **each day**.

Example: If your goal was to add 4 and 1/2 Liters of Kalkwasser to your aquarium every day, you would set the daily total FLOW value to read **04.50**.

Example: if your goal was to add two gallons of Kalkwasser to your aquarium per day, you would set the daily total FLOW value to read **07.56** (1 U.S. Gallon = 3.78 Liters x 2 = 7.56 Liters).

- 4) Change the STATUS from OFF to RUN and the pump will operate just long enough, 150 times a day to deliver the total daily FLOW. Changing the STATUS from OFF to ON will cause the pump to operate continuously until the STATUS is changed to OFF.

Power outages will not affect the LiterMeter III. If power is removed from the unit, and then re-applied, timing and control will commence with the same settings as before the power outage.

OVER LIMIT

If the requested daily total (FLOW) is more than the pump's capacity, the display will indicate the STATUS as OVL, or an Over Limit condition. In this case, the pump will be turned off and the daily total (FLOW) will be adjusted to indicate the maximum FLOW attainable with that pump. Change the STATUS to OFF and either adjust the requested FLOW to a more suitable value, or change the STATUS back to RUN to use the adjusted maximum FLOW.

SpectraPure®

Typical System Example

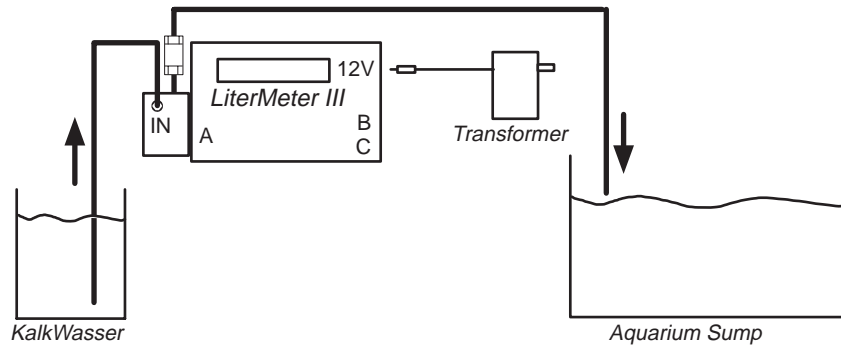

SYSTEM OPERATION

The LiterMeter III can control up to three dispensing devices in a sequential/cyclical manner. **Only one device may be on at a time.** The diagram below depicts maximum ON times for each device.

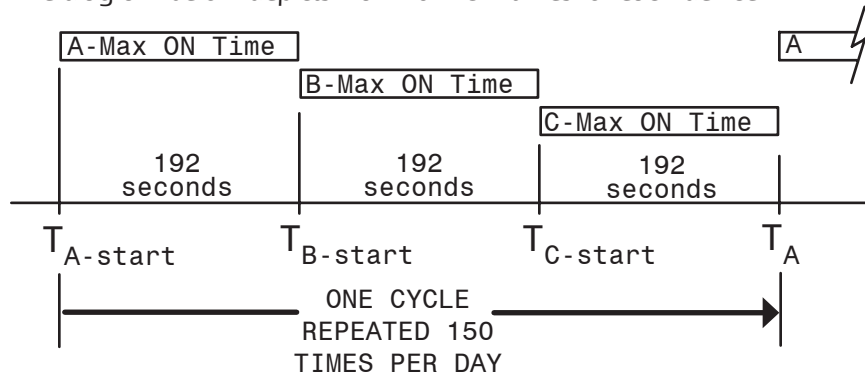

Every time the RUN/STOP switch is pressed, the operating MODE changes between RUN and STOP. In STOP mode, the pumps are disabled and the display will read *ALL PUMPS OFF*. When in STOP mode, the Calibrate and Maintenance functions are available. When in RUN mode, the pump(s) operate according to the current parameters. **Note: if the requested daily total (FLOW) is less than approx. 150 ml/day, the pump may not immediately activate during the initial dosing cycle.**

SpectraPure@Inc. Fax 480.894.6109 Fax us toll-free 1.877.527.7873
E-mail: spectra@spectrapure.com Visit us on the web www.spectrapure.com

SpectraPure®

THE LIGHTS (LEDs)

The PoWeR LED indicates the wall-mounted power supply is functioning and the unit has power.

The SYSTEM LED normally blinks (in RUN mode) every other second, indicating that proper operation and time-keeping are proceeding.

Three PUMP LEDs indicate power is being applied to the pump motors. You may notice a very dim glow when a pump is off or not connected. This is a self-test function and not an error. If a pump LED is on, but the pump does not run, the pump head may be dirty and require servicing, or there may be a problem with the pump motor.

THE BUTTONS

When the LiterMeter III is in RUN mode, the group of four navigation buttons are used to change the RATE, FLOW and STATUS of the individual pumps. LEFT and RIGHT move the cursor across the display. UP and DOWN change the parameters (See pages 10-11).

When the unit is in STOP mode, the CALIBrate and MAINTenance functions are available. These functions display a series of questions that can be answered YES or NO.

THE INFORMATION DISPLAY

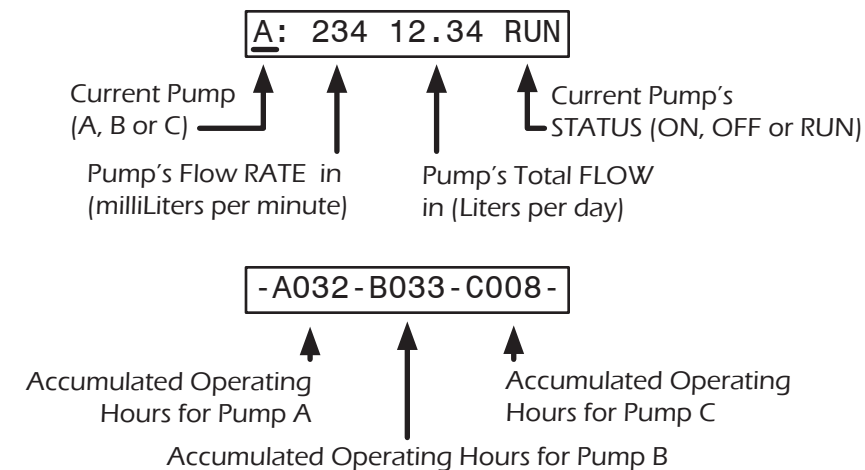

SpectraPure®

How to NAVIGATE across the Information Display

Move cursor LEFT and RIGHT across display to access and change parameters

How to View PUMP parameters

Step through three pump parameter displays and accumulated hours display

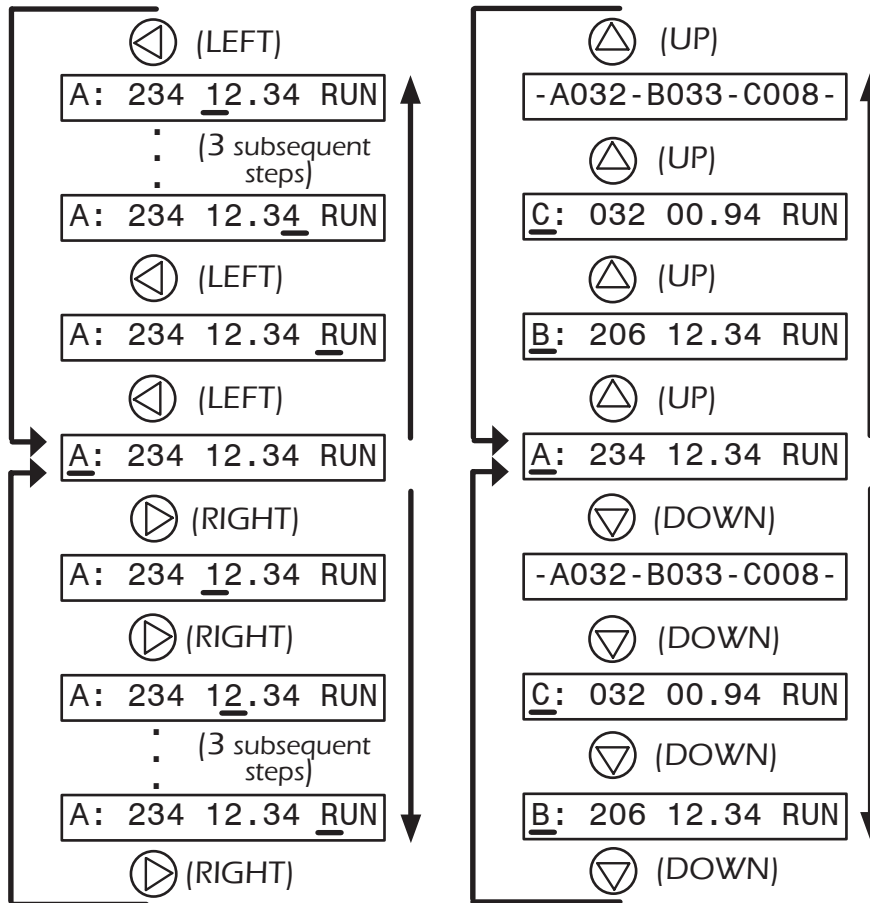

SpectraPure®

How to Change the Total Amount of FLOW per day

Digits are stored as they are changed. Dosing schedule is re-calculated when STATUS is changed from OFF to RUN.

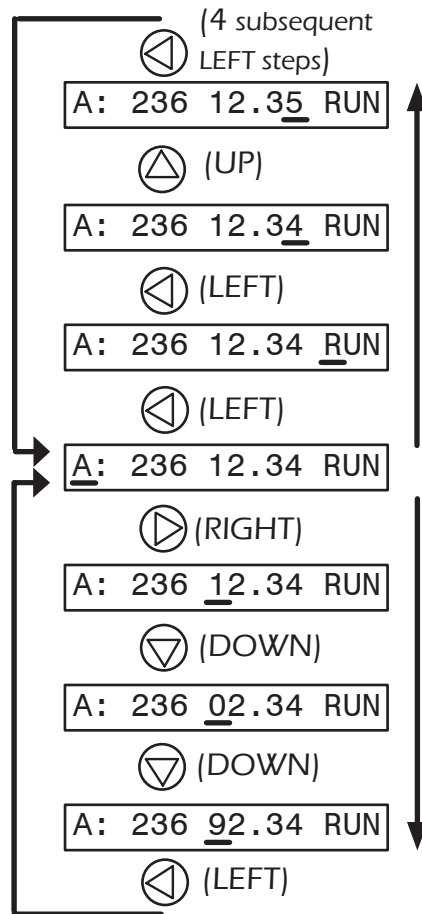

How to Change Pump Operation STATUS

OFF = Pump is always OFF
 ON = Pump is always ON
 RUN = Pump is dosing per parameter values

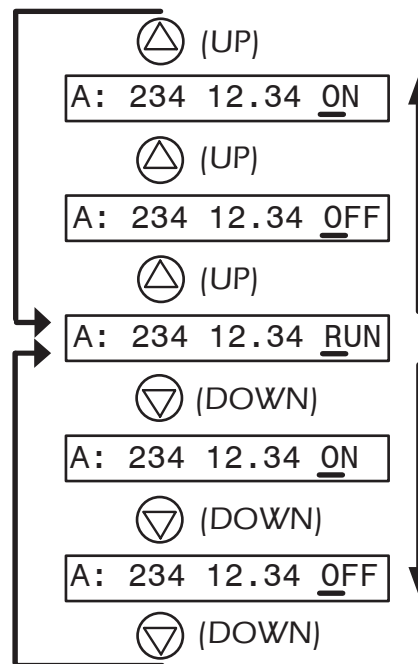

SpectraPure®

MAINTENANCE

Very little maintenance is required to keep your LiterMeter III operating reliably for many years. The LiterMeter III has a Service Interval Timer (300 hours of run time) for each pump. When a pump's accumulated ON time exceeds the Service Interval Time Limit, the LiterMeter III will beep once per minute and flash a message on the display until the pump head is inspected and/or serviced and the Service Interval Timer is reset.

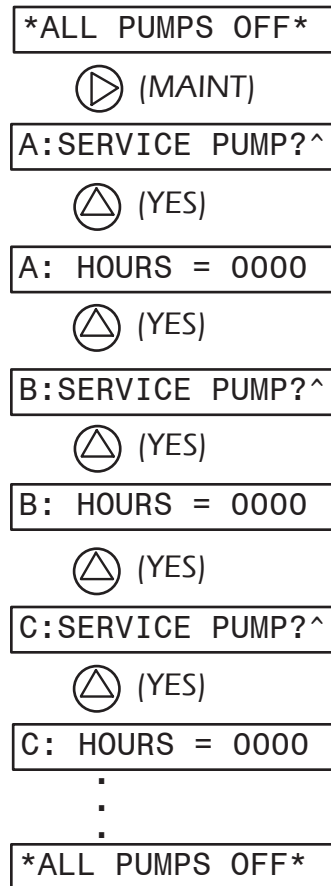

To reset the Service Interval Timer:

- 1: Be sure that **all pumps are off**.
- 2: Press the MAINT button (RIGHT) to display the pump that needs service. If, for example, Pump A has exceeded the Service Interval Time, the display will ask if you have serviced that pump. The pump head service procedure is described on page 14.
- 3: Answer YES by pressing the UP button.
- 4: The Service Interval Timer for Pump A will be reset to 0000 hours.
- 5: If other pumps need servicing, they will be displayed next.
- 6: If there are no other pumps that need service, the LiterMeter III will return to the *ALL PUMPS OFF* display.

As with any user-calibrated device, a periodic re-calibration should be performed to maintain original specifications.

SpectraPure®

CHANGING THE SERVICE INTERVAL PERIOD

Very little maintenance is required to keep your LiterMeter III operating reliably for many years. The LiterMeter III has a Service Interval Timer (300 hours of run time) for each pump. As long as service is NOT required, you can change the number of hours between Service Alerts.

g
300
ime
:e
:

ALL PUMPS OFF

▶ (MAINT)

HRS NXT SVC: 300

▲ (UP)

HRS NXT SVC: 400

▶ (RIGHT)

HRS NXT SVC: 400

▶ (RIGHT)

HRS NXT SVC: 400

▶ (RIGHT)

ALL PUMPS OFF

To change the Service Interval Timer:

- 1: Be sure that **all pumps are off**.
- 2: Press the MAINT button (RIGHT) to display the Service Interval Period. The cursor should be under the "3" in "300".
- 3: Increase or Decrease that digit as desired.
- 4: Press the MAINT button to move the cursor and change each digit individually.
- 5: The third right arrow press will return the display to * ALL PUMPS OFF*.

SpectraPure®Inc. 480.894.5437 Call us toll-free 1.800.685.2783

SpectraPure[®]

ACCESSORIES



LM3-TCM

Top-off Control Module – Plastic box with built-in Liquid Level Control (LLC). Connects to 12V input of LiterMeter III to interrupt power if or when high liquid level is reached.

3.0" x 2.0" x 1.7" (7.6 cm x 5.1 cm x 4.3 cm)

LM3-RPM

Remote Pump Module – LiterMeter III Pump mounted in plastic box. Connects to LiterMeter III for power and control. 5.4" x 2.2" x 2.2" (13.7 cm x 5.6 cm x 5.6 cm)



LM3-WXM

Water eXchange Module – LiterMeter III Pump mounted in plastic box with built-in Liquid Level Control (LLC). Interrupts power to pump if or when high liquid level is reached. Connects to LiterMeter III for power and control.

5.4" x 2.2" x 2.2" (13.7 cm x 5.6 cm x 5.6 cm)



SpectraPure®

TWO-WAY WATER EXCHANGE

Two-way water changes have been a problem in the past. Two pump heads mounted on one shaft can have different flow RATES and thus unequal totals after a period of time. The LiterMeter III solves this problem by providing individual pump flow RATE calibrations. With two pumps properly calibrated, a constant water exchange system can be set up.

In the example below, Pump A dispenses nutrients or kalkwasser. Pump B is the Water eXchange Module. It takes water from a pre-prepared reservoir of fresh salt water and meters it into the aquarium. Pump C is a Remote Pump Module that takes an equal amount of water from the aquarium and sends it to the drain. The air line & sensor attached to the Water eXchange Module will insure against over-filling the sump due to a system failure.

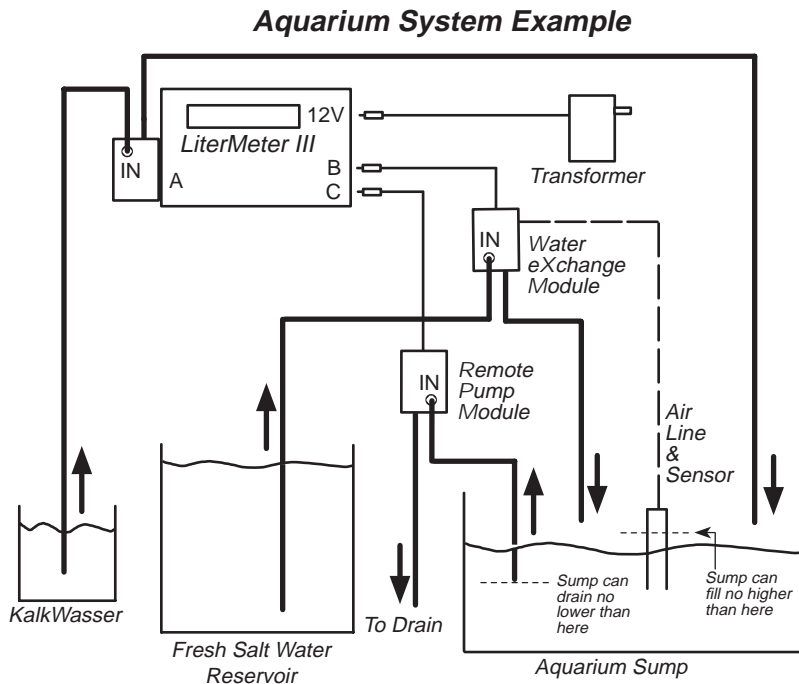

SpectraPure®

DOSING MULTI-PART ADDITIVES

Many different brands of 2- and 3-part additives are available today. For example, using the B-Ionic and C-Balance products, the LiterMeter III enables you to automate the daily additions of both components.

In the example below, Pump A dispenses "Additive Part A". Pump B is a Remote Pump Module and dispenses "Additive Part B". A micro-nutrient or "Additive Part C" is dispensed by another Remote Pump Module. The optional Top-off Control Module will shut the entire system down if the sump level were to ever become too high.

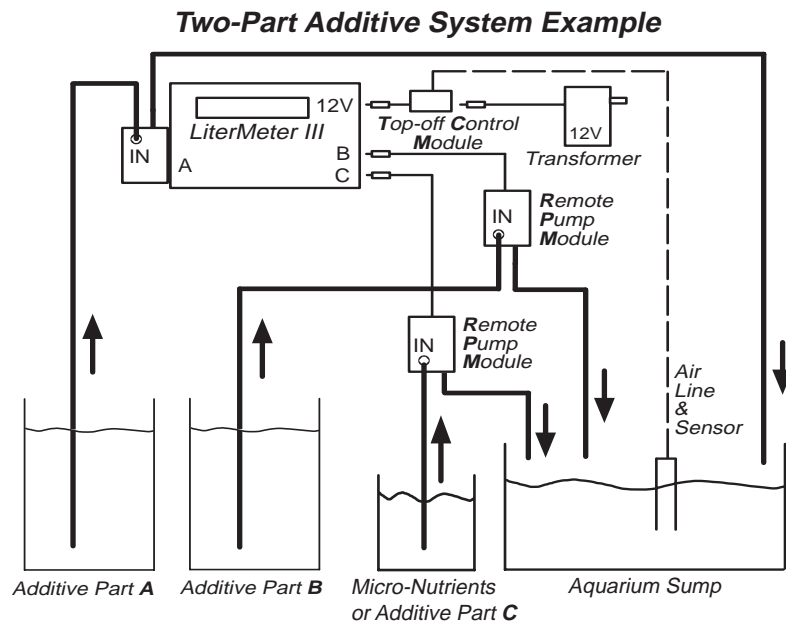

SpectraPure®

HYDROPONICS SYSTEM EXAMPLE

An example using the LiterMeter III for the hydroponics industry is shown below. Nutrient components "A" and "B" are metered and mixed in precise amounts into the hydroponics reservoir. At the same time, an amount equal to "A" plus "B" is removed from the reservoir by Pump C. Small but constant replenishments of the nutrient is conducive to proper plant growth. The optional Top-off Control Module will shut the entire system down if the reservoir level becomes too high.

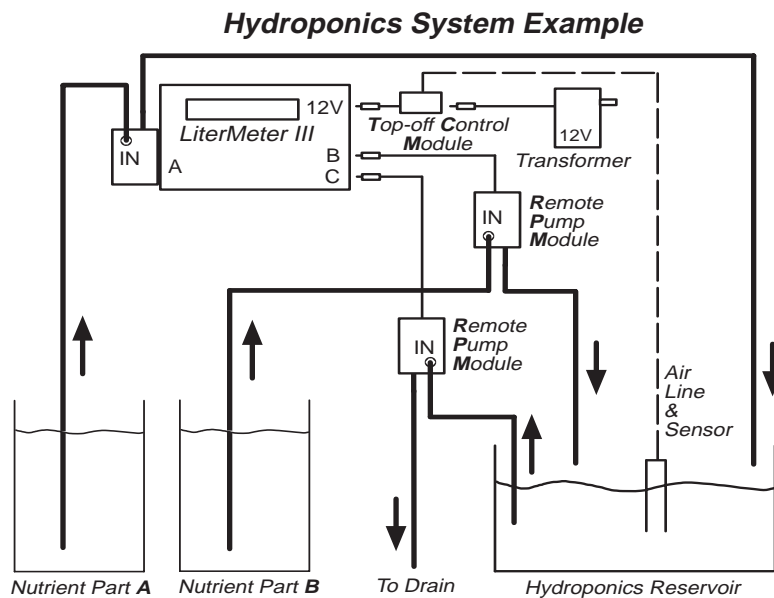

CONTROLLING OTHER DEVICES

Connecting an external device to the "A" output jack will disable the internal pump. All three outputs can control many different devices for various applications. **Interface specifications are 12 Volts, DC at no more than 500 milliamps.** This is adequate to power many types of solenoids, relays and pumps. The connector is a 1/8" (3.5mm) male plug, center pin is positive.

SpectraPure[®]

TROUBLESHOOTING

Symptom	Remedy
Noise	The LiterMeter III is considered the quietest pump on the market, but the pump will produce some noise. Here are some suggestions to limit any perceived noise. 1. Do not attach the LiterMeter to a box or enclosure that will act as a "speaker" and amplify the vibration of the pump. 2. Keep the attached tubing from vibrating against nearby walls, cabinets or other objects.
Lights and Display are on, but rollers are not turning	Determine if drive shaft is rotating. If not: Call Technical Support. If shaft is turning: The pump head needs to be cleaned.
Pump is running but no fluid is being pumped	1. Check the ends of the tubing. Kalkwasser or other substances may be blocking the lines at either tubing end. 2. Loose connection on the Suction side will cause it to lose its prime.

ACCESSORIES & REPLACEMENT PARTS:

	Catalog No.	Optional Part	Price
	LM3-RPM	Remote Pump Module	\$139
	LM3-WXM	Water eXchange Module	\$169
	LM3-TCM	Topoff Control Module	\$ 39
	LM3-TBN-KIT	Tubing Replacement Kit (metal pump)	\$ 15
	LM-TBN-KIT	Tubing Replacement Kit (plastic pump)	\$ 15

SpectraPure[®]

SERVICING THE LiterMeter III

It is recommended that the pump head be inspected and cleaned, or the tubing replaced per the following procedure.

- 1: Use a thumbnail to lift the union coupler off and away from the output tube (Fig. B-1).



Fig. B-1



Fig. B-2

- 2: Use a 3/32" Allen Hex Key to remove the three bolts in the pump head and lift the pump head away from the motor shaft. (Fig. B-2)
- 3: Remove the three white rollers and tubing from the head.
- 4: If they are dirty, clean the three white rollers, tubing, lid and body with a cloth soaked in De-Solv-it[®] (available in most grocery stores), acetone, or petroleum spirits. Make sure you remove all gummy deposits then rinse parts with water and dry. Next, wipe the motor shaft clean. If you use acetone, be careful not to spill on the plastic case or it will damage the finish. Keep cleaning fluids away from the bearing at the base of the shaft.

SpectraPure[®]

5: Remove the tubing from the pump head as shown in Fig. B-3.



Fig. B-3

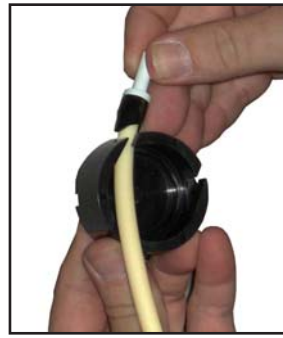

Fig. B-4

- 6: Replace tubing assembly with new replacement tubing assembly. Reinstall by pinching the tubing one inch from the studded end and inserting it into the outlet port of the pump body. (Fig. B-4)
- 7: Pinch the other end of the tubing and insert it into the inlet port of the pump body. Manipulate the tubing so that it conforms to the inside diameter of the pump body. **Be sure that the tubing is completely pushed down into the ports and the clear "wear tab" (peeking out from under the black collar) is oriented to the inside.** See Fig. B-5.



Fig. B-5

SpectraPure[®]

- 8: Place two of the three rollers into the pump body, pushing them against the tubing. Hold them in position with your left thumb and then push the third roller into place. (Fig. B-6 and B-7)



Fig. B-6



Fig. B-7

- 9: Carefully align and press the pump head assembly onto the motor shaft. (Fig. B-8)
- 10: Push the pump head firmly against the pump body and check for proper alignment. (Fig. B-9)



Fig. B-8



Fig. B-9

SpectraPure[®]

11: Use the 3/32" Allen Hex Key to re-install the three pump head bolts. (Fig. B-10)

12: Replace the union connector on the output port stud. (Fig. B-11)



Fig. B-10



Fig. B-11

13: The final assembly should look like Fig. B-12.



Fig. B-12

14: Before you re-calibrate your LiterMeter, a short break-in period is needed to insure an accurate calibration. Run it dry for 20 minutes. Next, follow the calibration procedure outlined in the manual.

SpectraPure[®]

FIVE YEAR LIMITED WARRANTY

Effective on products purchased after June 11, 2007

SpectraPure, Inc. warrants each new LiterMeter III Precision Dosing System to the original owner only to be free of defects in material and workmanship for a period of 5 years from the date of receipt. SpectraPure's liability under this warranty shall be limited to repairing or replacing on SpectraPure's option, without charge, F.O.B. SpectraPure's factory, any product of SpectraPure's manufacture. SpectraPure will not be liable for any cost of removal, installation, transportation, or any other charges which may arise in connection with a warranty claim. Products which are sold but not manufactured by SpectraPure are subject to warranty provided by the manufacturer of said products and not by SpectraPure's warranty. SpectraPure will not be liable for damage or wear to products caused by abnormal operating conditions, accident, abuse, misuse, unauthorized alteration, or repair, or if the product was not installed in accordance with SpectraPure's printed installation and operating conditions or damage caused by power failures, freezing, flood, fire, or acts of God.

TERMS AND CONDITIONS OF SALE

To obtain service under this warranty, the defective system or components must be returned to SpectraPure with proof of purchase, installation date and failure date.

Any defective product to be returned to the factory must be sent freight prepaid; documentation supporting the warranty claim and/or a Return Goods Authorization must be included, if so instructed.

SpectraPure will not be liable for any incidental or consequential damages, losses, or expenses arising from installation, use, or any other causes. There are no expressed or implied warranties, including merchantability or fitness for a particular purpose, which extend beyond those warranties described or referred to above.

Some jurisdictions do not allow the exclusion or limitation of incidental or consequential damages and some jurisdictions do not allow limitations on how long implied warranties may last. Therefore, the above limitations or exclusions may not apply to you. This warranty gives you specific legal rights and you may also have other rights which vary jurisdiction to jurisdiction.

SpectraPure, Inc. reserves the right to change prices without notice when necessary.

SpectraPure[®] Inc. assumes no responsibility for water damage due to leaks or misapplications of our products. It is the user's responsibility to determine that the system is leak-free and properly installed.